



Instruction Manual

Wall-Mounting Bracket 350

Save These Instructions

This manual contains instructions and warnings that must be followed during the installation and operation of the product described in this manual. Failure to comply may invalidate the warranty and cause property damage or personal injury.

Thank you for purchasing a TecMOJO product. Please check the product carefully and contact TecMOJO for assistance if any parts are damaged or missing. Do not attempt to install or use product if it has been damaged. This product contains small items that could be a choking hazard – keep these items away from children.

For permanent wall mounting, be sure to securely fasten the enclosure to the building structure before operation.

Do not use with equipment that is heavier than the indicated weight capacity for this product. This product is designed to be installed indoors on wood stud walls, solid concrete walls or brick walls. Make sure that the supporting surface will safely support the weight of the equipment and all attached hardware and components. It is recommended that installation be performed by a qualified installer. TecMOJO cannot be held responsible for damage to equipment or personal injury resulting from improper use or installation of product.

Maintenance: we recommend checking on regular basis that the product is secure and safe to use.



Limitations of Liability: In no event will TecMOJO Co. be liable for any damages, whether direct or indirect, special, punitive, incidental or consequential damages (including, but not limited to, lost profits or revenue, loss of use, lost business opportunities or loss of goodwill) or for the costs of procuring substitute products, arising out of or in connection with the use of the product, whether such liability arises from any claim based upon contract, warranty, tort (including negligence), product liability or otherwise, whether or not seller has been advised of the possibility of such loss or damage. In no event will seller's total cumulative liability, from all causes of action and all theories of liability, exceed the total amounts actually paid to seller by customer under the order that gives rise to any liability hereunder.

Specification:

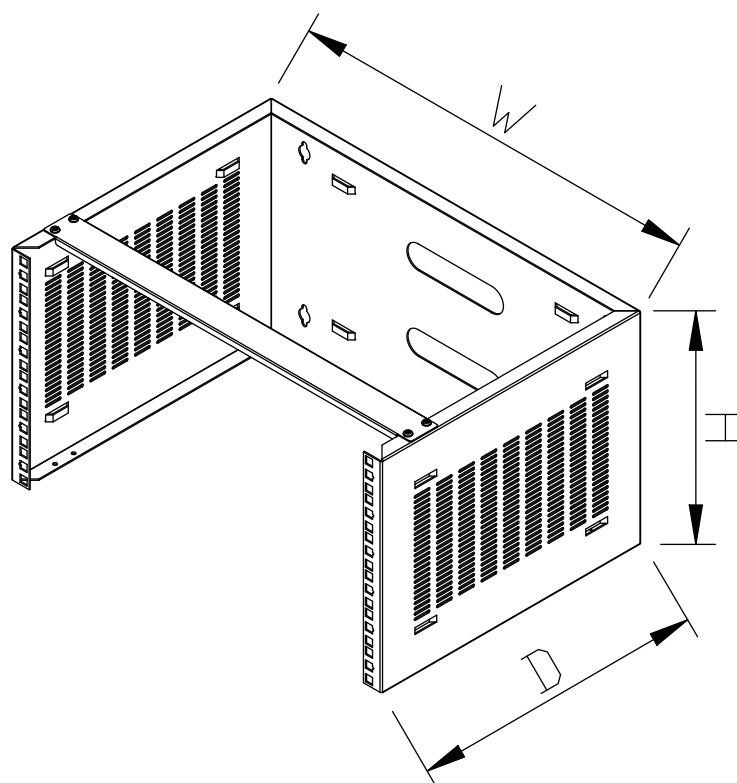
SKU#	Capacity(U)	Width(mm)	Depth(mm)	Height(mm)
11130501	2	498	350	94
11130502	4			183
11130503	6			272
11130504	8			361
11130505	10			450
11130506	12			539
11130507	14			628

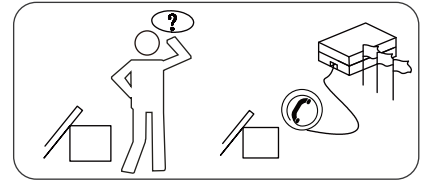
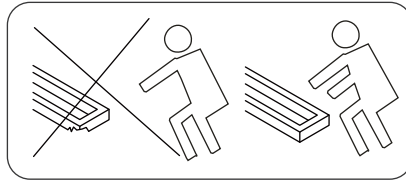
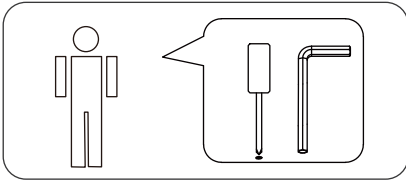



ITEM	CAPACITY QTY	ITEM	2U	4U	6U	8U	10U	12U	14U
			3X100 cable ties		10	10	10	10	10
M5*30 Phillips wood screw			4	4	4	4	4	4	4
Accessory kits : screws			8	16	24	32	40	40	40

